



Type VRFU90 needle valves

- With check valve

Technical specifications and diagrams are measured with mineral oil of 46 cSt viscosity at 40°C (104°F) temperature.

	VRFU9001	VRFU9002	VRFU9003	VRFU9004	VRFU9005
Nominal flow from A to B	30 l/min (7.9 US gpm)	40 l/min (10.6 US gpm)	50 l/min (23.8 US gpm)	80 l/min (21.1 US gpm)	110 l/min (29.1 US gpm)
Nominal flow from B to A	35 l/min (9.2 US gpm)	50 l/min (23.8 US gpm)	90 l/min (23.8 US gpm)	140 l/min (37 US gpm)	180 l/min (47.6 US gpm)
Max. pressure	350 bar (5100 psi)	350 bar (5100 psi)	350 bar (5100 psi)	320 bar (4600 psi)	300 bar (4350 psi)
Fluid	mineral based oil				
Viscosity	from 10 to 200 cSt				
Max. level of contamination	18/16/13 ISO4406				
Fluid temperature	with NBR seals from -30°C (-22°F) to 80°C (176°F)				
Environmental temperature for working conditions	from -40°C (-40°F) to 100°C (212°F)				
Weight	steel 0.40 kg (0.88 lb)	0.41 kg (0.9 lb)	0.58 kg (1.28 lb)	1.39 kg (3.06 lb)	1.36 kg (3 lb)

NOTE - For different conditions, please contact Walvoil Sales Dpt.

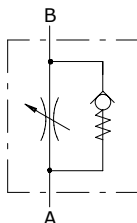

Dimensions

Dimensions are in mm-in

Valve type	All ports	A	B	C	D	E	F
VRFU9001	G1/4	75 - 2.95	82 - 3.23	25 - 0.98	29 - 1.14	M25X1.5	30 - 1.18
VRFU9002	G3/8	78 - 3.07	82 - 3.23	25 - 0.98	31 - 1.22	M25X1.5	30 - 1.18
VRFU9003	G1/2	93 - 3.66	88 - 3.46	30 - 1.18	33.5 - 1.32	M25X1.5	30 - 1.18
VRFU9004	G3/4	110 - 4.33	116 - 4.57	40 - 1.57	41.5 - 1.63	M35X1.5	42 - 1.65
VRFU9005	G1	135 - 5.31	116 - 4.57	40 - 1.57	44.5 - 1.75	M35X1.5	42 - 1.65

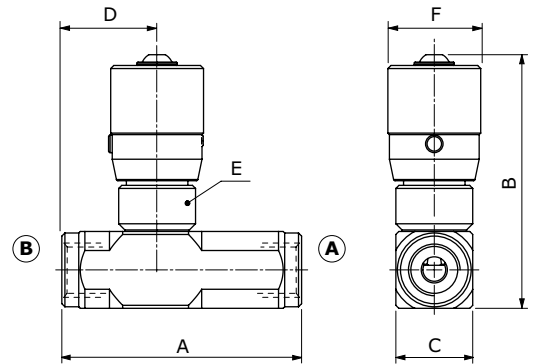

Ordering codes and description composition

VRFU90 01 └─ Port size

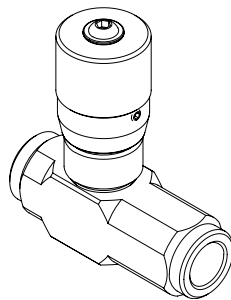

VRFU90 complete valves

TYPE	CODE	DESCRIPTION
VRFU9001	1605110100	Steel body, G1/4 ports, opening pressure 0.5 bar (7.25 psi)
VRFU9002	1605120100	Steel body, G3/8 ports, opening pressure 0.5 bar (7.25 psi)
VRFU9003	1605130100	Steel body, G1/2 ports, opening pressure 0.5 bar (7.25 psi)
VRFU9004	1605140100	Steel body, G3/4 ports, opening pressure 0.5 bar (7.25 psi)
VRFU9005	1605150100	Steel body, G1 ports, opening pressure 0.5 bar (7.25 psi)

For different configurations or SAE thread please contact our Sales Dpt.

Rating diagram

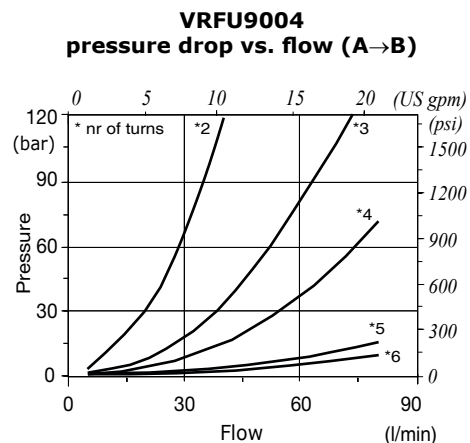
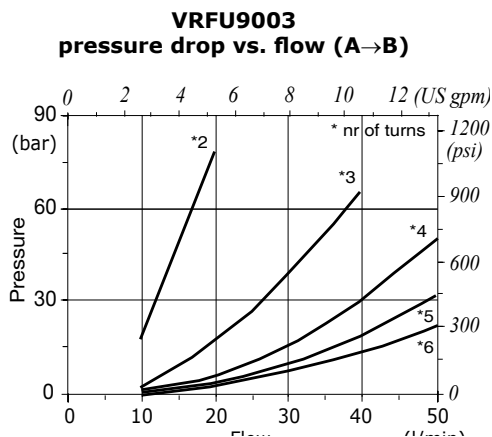
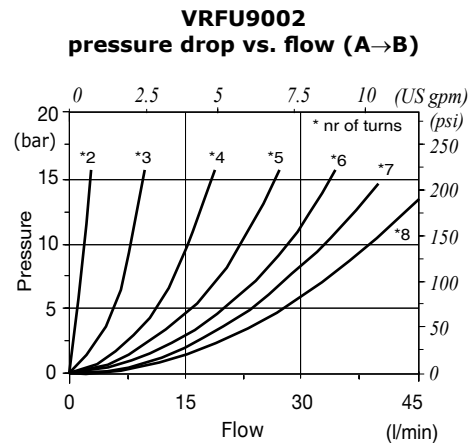
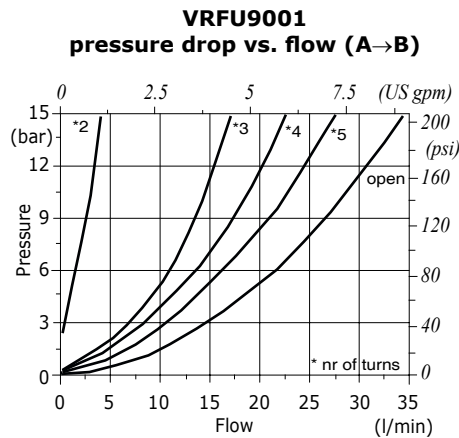

Rating diagram

VRFU9005
pressure drop vs. flow (A→B)

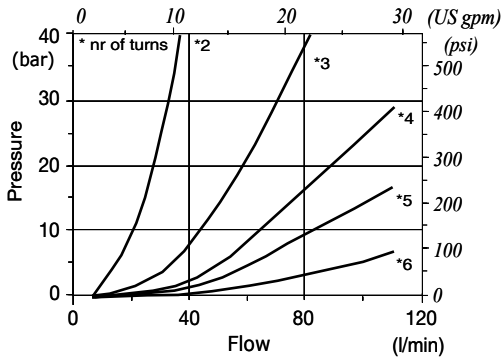

VRFU9001
pressure drop vs. flow (B→A)

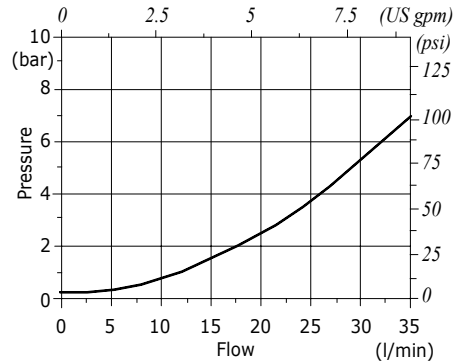

VRFU9002
pressure drop vs. flow (B→A)

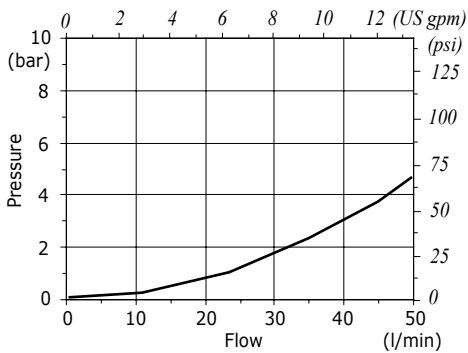

VRFU9003
pressure drop vs. flow (B→A)

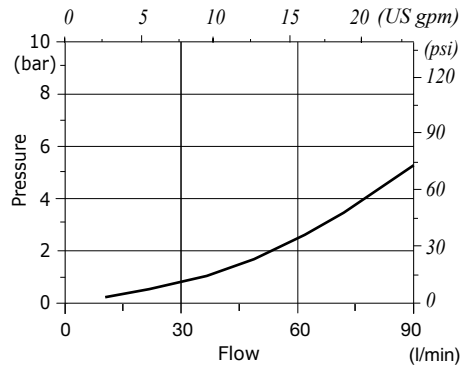

VRFU9004
pressure drop vs. flow (B→A)

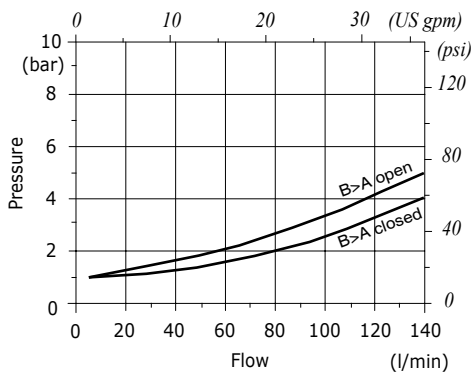

VRFU9005
pressure drop vs. flow (B→A)

