



Type VE/B/VMP/VUI/SR directional solenoid valves

- Single acting cylinder

Technical specifications and diagrams are measured with mineral oil of 46 cSt viscosity at 40°C (104°F) temperature.

	VE/B/VMP/ VUI/SR 14	VE/B/VMP/ VUI/SR 38	VE/B/VMP/ VUI/SR 12	VE/B/VMP/ VUI/SR 34	VE/B/VMP/ VUI/SR 100	
Nominal flow	20 l/min (5.3 US gpm)	35 l/min (9.2 US gpm)	65 l/min (17.2 US gpm)	70 l/min (18.5 US gpm)	150 l/min (39.6 US gpm)	
Max. pressure	Aluminium body = 210 bar (3050 psi) Steel body = 350 bar (5100 psi)					
Oil leakage	0.25 cm ³ /min. - 0.015 in ³ /min. (5 drops) at 210 bar - 3050 psi					
Fluid	mineral based oil					
Viscosity	from 10 to 200 cSt					
Max. level of contamination	18/16/13 ISO4406					
Fluid temperature	with NBR seals from -20°C (-4°F) to 80°C (176°F)					
Environmental temp. for working conditions	from -40°C (-40°F) to 100°C (212°F)					
Weight	aluminium	1.32 kg (2.91 lb)	1.32 kg (2.91 lb)	3.01 kg (6.64 lb)	3.01 kg (6.64 lb)	5.00 kg (11.02 lb)
	steel	2.65 kg (5.84 lb)	2.65 kg (5.84 lb)	3.19 kg (7.03 lb)	3.19 kg (7.03 lb)	10.03 kg (22.11 lb)

NOTE - For different conditions, please contact Walvoil Sales Dpt.

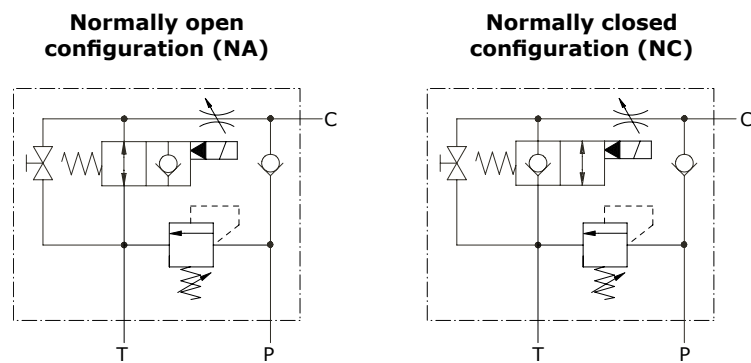

Dimensions

Valve type	All ports
VE/B/VMP/VUI/SR 14	G1/4
VE/B/VMP/VUI/SR 38	G3/8
VE/B/VMP/VUI/SR 12	G1/2
VE/B/VMP/VUI/SR 34	G3/4
VE/B/VMP/VUI/SR 100	G1"

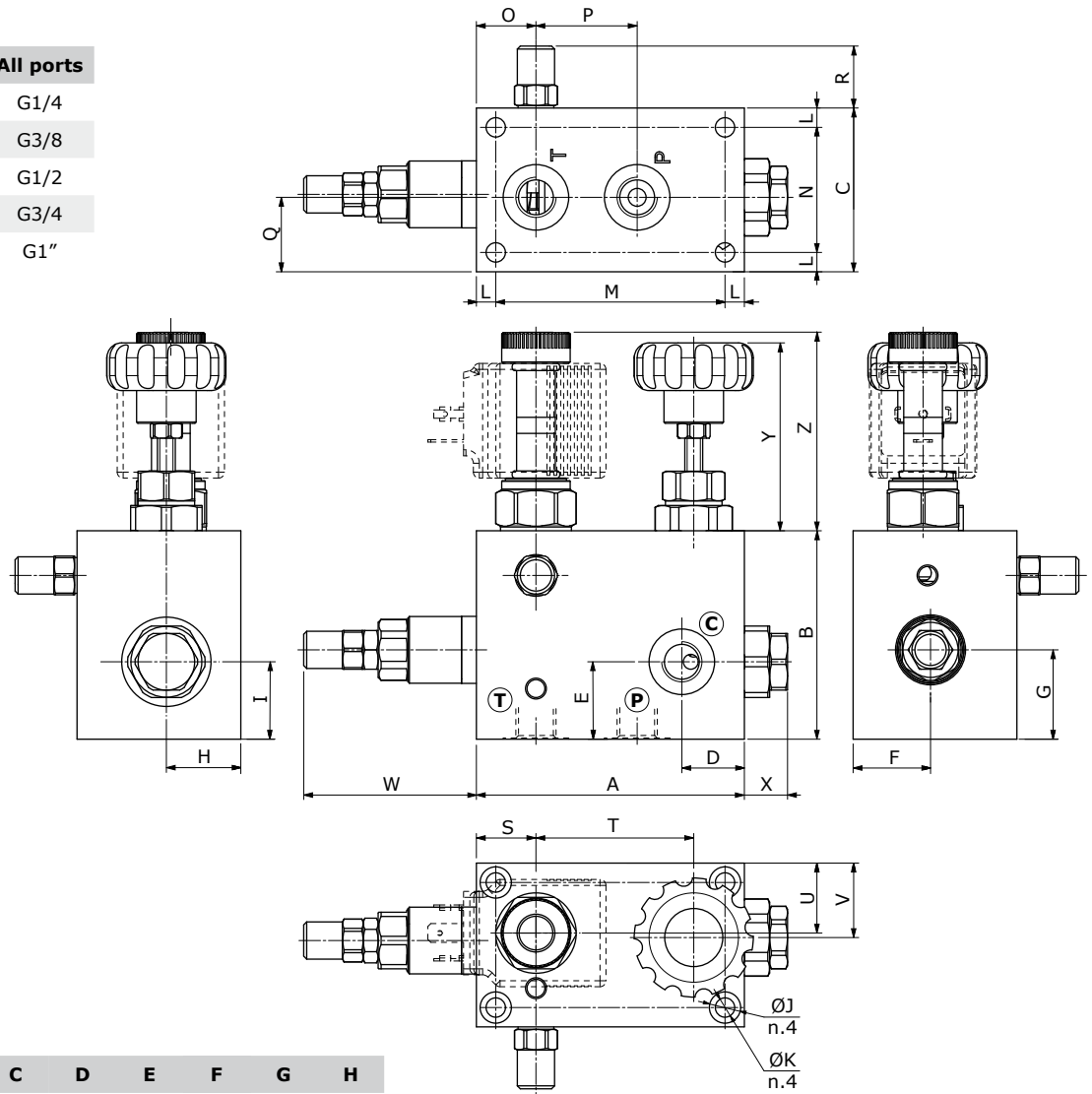

Dimensions are in mm-in

Valve type	A	B	C	D	E	F	G	H
VE/B/VMP/VUI/SR 14	90 3.54	70 2.76	55 2.17	21 0.83	26 1.02	26 1.02	30 1.18	25 0.98
VE/B/VMP/VUI/SR 38	90 3.54	70 2.76	55 2.17	22 0.87	26 1.02	26 1.02	30 1.18	25 0.98
VE/B/VMP/VUI/SR 12	115 4.53	100 3.94	70 2.76	28 1.10	38.5 1.53	32 1.26	38.5 1.53	32 1.26
VE/B/VMP/VUI/SR 34	115 4.53	100 3.94	70 2.76	30 1.18	38.5 1.53	32 1.26	38.5 1.53	32 1.26
VE/B/VMP/VUI/SR 100	150 5.91	120 4.72	80 3.15	37 1.46	45 1.77	36 1.42	45 1.77	36 1.42

Valve type	I	J	K	L	M	N	O	P	Q	R	S	T	U	V	W	X	Y	Z	
																		(NA)	(NC)
VE/B/VMP/VUI/SR 14	26 1.02	10.5 0.413	6.5 0.256	6.5 0.256	77 3.03	42 1.65	20 0.79	34 1.34	25 0.98	20.8 0.82	20 0.79	53 2.09	23.5 0.93	25 0.98	58 2.28	14.5 0.571	63 2.48	66.7 2.63	62.8 2.47
VE/B/VMP/VUI/SR 38	26 1.02	10.5 0.413	6.5 0.256	6.5 0.256	77 3.03	42 1.65	20 0.79	34 1.34	25 0.98	20.8 0.82	20 0.79	53 2.09	23.5 0.93	25 0.98	58 2.28	14.5 0.571	63 2.48	66.7 2.63	62.8 2.47
VE/B/VMP/VUI/SR 12	38.5 1.53	13.5 0.531	8.5 0.335	8.5 0.335	98 3.86	53 2.09	29 1.14	37 1.46	29 1.14	23.8 0.94	29 1.14	61 2.40	29 1.14	29 1.14	56.5 2.22	11 0.433	72.5 2.85	86.4 3.40	81 3.19
VE/B/VMP/VUI/SR 34	38.5 1.53	13.5 0.531	8.5 0.335	8.5 0.335	98 3.86	53 2.09	29 1.14	41 1.61	29 1.14	23.5 0.93	29 1.14	61 2.40	29 1.14	29 1.14	56.5 2.22	11 0.433	72.5 2.85	86.4 3.40	81 3.19
VE/B/VMP/VUI/SR 100	45 1.77	16.5 0.65	10.5 0.413	10 0.394	130 5.12	60 2.36	27 1.06	60 2.36	36 1.42	23.5 0.93	27 1.06	91 3.58	36 1.42	36 1.42	71 2.80	16.5 0.65	83 3.27	79.4 3.13	74.2 2.92

Ordering codes and description composition

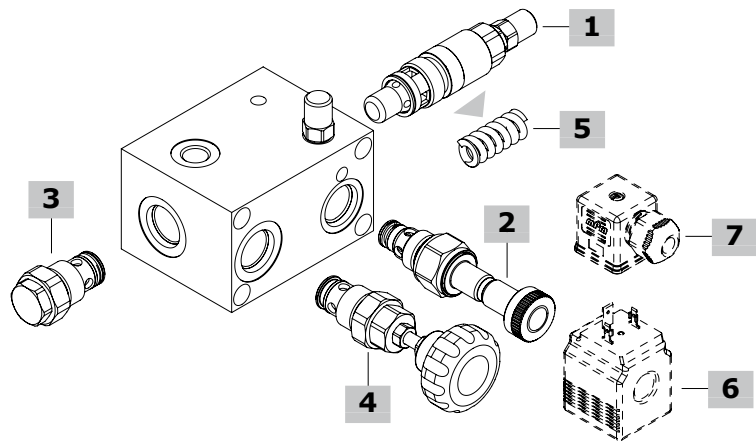
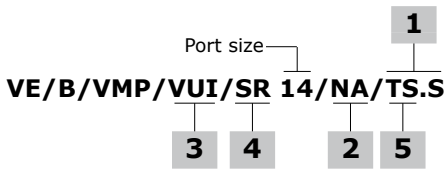

VE/B/VMP/VUI/SR complete valves

Aluminium body and VMP direct type valve configuration
 Standard setting 160 bar at 5 l/min (2320 psi at 1.32 US gpm)
 Setting range: 50-220 bar (725-3200 psi)

TYPE	CODE	DESCRIPTION
(NA) normally open solenoid valve configuration		
VE/B/VMP/VUI/SR 14/NA/TS.S	1900511101	G1/4 ports
VE/B/VMP/VUI/SR 38/NA/TS.S	1900521103	G3/8 ports
VE/B/VMP/VUI/SR 12/NA/TS.S	1900531110	G1/2 ports
VE/B/VMP/VUI/SR 34/NA/TS.S	1900541106	G3/4 ports
VE/B/VMP/VUI/SR 100/NA/TS.S	1900551110	G1" ports
(NC) normally closed solenoid valve configuration		
VE/B/VMP/VUI/SR 14/NC/TS.S	1900511100	G1/4 ports
VE/B/VMP/VUI/SR 38/NC/TS.S	1900521102	G3/8 ports
VE/B/VMP/VUI/SR 12/NC/TS.S	1900531109	G1/2 ports
VE/B/VMP/VUI/SR 34/NC/TS.S	1900541105	G3/4 ports
VE/B/VMP/VUI/SR 100/NC/TS.S	1900551109	G1" ports
VE/B/VMP/VUI/SR 38/NC/TS.S/SAE	1900521200	SAE8 ports
VE/B/VMP/VUI/SR 12/NC/TS.S/SAE	1900531200	SAE10 ports

For other steel body configurations, SAE thread, other port sizes and configurations with FPM (Viton) seals, please contact our Sales Dpt.

1 Pressure relief valve

TYPE	CODE	DESCRIPTION
For VE/B/VMP/VUI/SR 14 and 38 valves		
VMP 5/TS.S	1100520400	Setting range 50-220 bar (725-3200 psi)
For VE/B/VMP/VUI/SR 12 and 34 valves		
VMP 10/TS.S	1100530400	Setting range 50-220 bar (725-3200 psi)
For VE/B/VMP/VUI/SR 100 valve		
VMP 20/TS.S	1100540400	Setting range 50-220 bar (725-3200 psi)

2 Solenoid valve

TYPE	CODE	DESCRIPTION
For VE/B/VMP/VUI/SR 14 and 38 valves: BER coils required		
EC08M/10NB	0EC08002031	(NA) normally open configuration
EC08M/20NB	0EC08002032	(NC) normally closed configuration
For VE/B/VMP/VUI/SR 12 and 34 valves: BER coils required		
EC10M/10NB	0EC10002012	(NA) normally open configuration
EC10M/20NB	0EC10002013	(NC) normally closed configuration
For VE/B/VMP/VUI/SR 100 valve: BER coils required		
EC16M/10NB	0EC16002020	(NA) normally open configuration
EC16M/20NB	0EC16002021	(NC) normally closed configuration

3 Check valve

TYPE	CODE	DESCRIPTION
For VE/B/VMP/VUI/SR 14 and 38 valves		
VUI 38/Pa0,5	1300020400	Opening pressure 0.5 bar (7.25 psi)
For VE/B/VMP/VUI/SR 12 and 34 valves		
VUI 12/Pa0,5	1300030400	Opening pressure 0.5 bar (7.25 psi)
For VE/B/VMP/VUI/SR 100 valve		
VUI 34/Pa0,5 pasmag	1300020400	Opening pressure 0.5 bar (7.25 psi)

4 Needle valve

TYPE	CODE	DESCRIPTION
For VE/B/VMP/VUI/SR 14 and 38 valves		
VUI/SR 38/V	1305020400	Handknob actuation
For VE/B/VMP/VUI/SR 12 and 34 valves		
VUI/SR 12/V	1305030400	Handknob actuation
For VE/B/VMP/VUI/SR 100 valve		
VUI/SR 34/V	1305040400	Handknob actuation

5 Pressure setting springs

TYPE	CODE	DESCRIPTION
For VE/B/VMP/VUI/SR 14 and 38 valves		
TB	3MOL314311	Setting range 5-40 bar (72.5-580 psi)
TV	3MOL314330	Setting range 20-80 bar (290-1150 psi)
TS	3MOL315330	Setting range 50-220 bar (725-3200 psi)
TR	3ML1143600	Setting range 180-350 bar (2600-5075 psi)
For VE/B/VMP/VUI/SR 12 and 34 valves		
TB	3MOL316410	Setting range 5-40 bar (72.5-580 psi)
TV	3ML1154300	Setting range 20-80 bar (290-1150 psi)
TS	3MOL317420	Setting range 50-220 bar (725-3200 psi)
TR	3MOL317440	Setting range 180-350 bar (2600-5075 psi)
For VE/B/VMP/VUI/SR 100 valve		
TB	3ML1184300	Setting range 5-40 bar (72.5-580 psi)
TV	3ML1174500	Setting range 20-80 bar (290-1150 psi)
TS	3ML1204200	Setting range 50-220 bar (725-3200 psi)
TR	3ML1214500	Setting range 180-350 bar (2600-5075 psi)

6 Coils

TYPE	CODE	DESCRIPTION
BER 12VDC	4SLE001200A	12VDC-ISO4400 for EC08M
BT 12VDC	4SL3000120	12VDC-ISO4400 for VSE/P/2 and VSE/P/2-150

For complete coils list see from page 433

7 Connector

TYPE	CODE	DESCRIPTION
ISO4400	4CN1009995	Connector

For complete connectors list see from page 433

Rating diagrams

VE/B/VMP/VUI/SR 14 pressure drop vs. flow from P→C - C→T

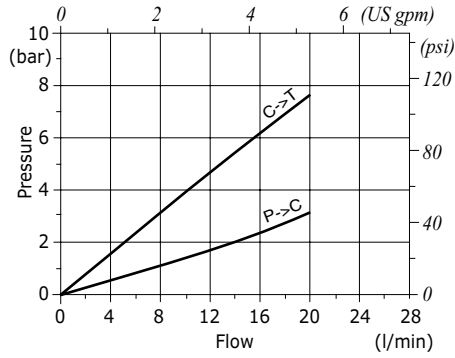

VE/B/VMP/VUI/SR 38 pressure drop vs. flow from P→C - C→T

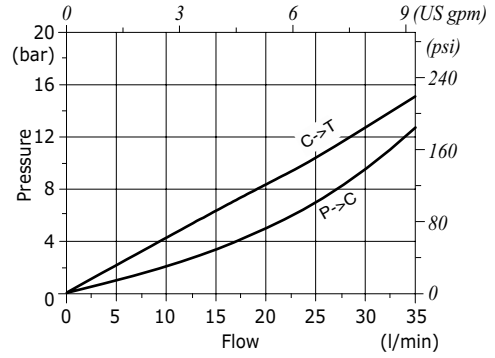

VE/B/VMP/VUI/SR (12-34) pressure drop vs. flow from P→C - C→T

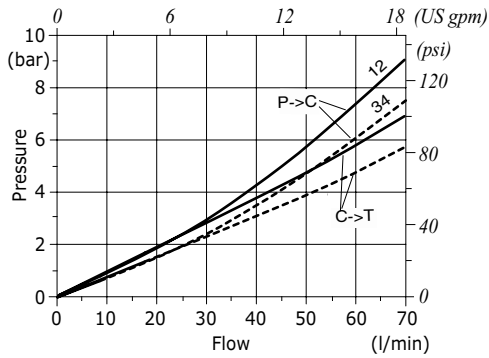

VE/B/VMP/VUI/SR 100 pressure drop vs. flow from P→C - C→T

